

Pilot Bore V-Pulleys according to BS3790 - 1981

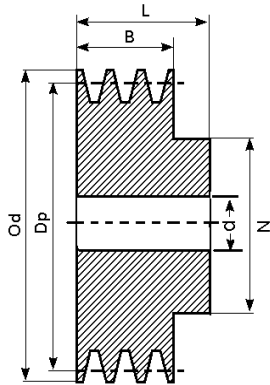

Form 1

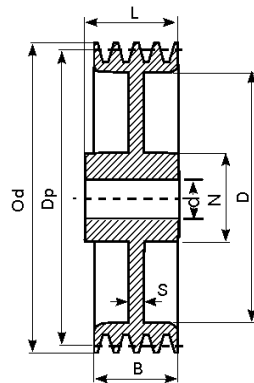

Form 3

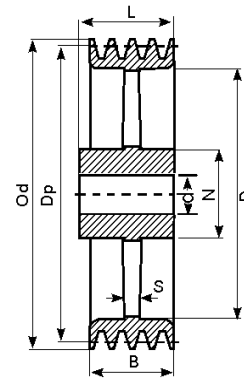

Form 5

SPZ - 1

Description	Od	Dp	Form	N	L	J	E	B	d
SPZ 50-1	54	50	1	40	28	—	—	16	10
SPZ 56-1	60	56	1	45	28	—	—	16	10
SPZ 63-1	67	63	1	50	28	—	—	16	10
SPZ 71-1	75	71	1	50	28	—	—	16	10
SPZ 75-1	79	75	1	50	28	—	—	16	10
SPZ 80-1	84	80	1	50	28	—	—	16	10
SPZ 85-1	89	85	1	50	28	—	—	16	10
SPZ 90-1	94	90	1	50	28	—	—	16	10
SPZ 95-1	99	95	1	50	28	—	—	16	10
SPZ 100-1	104	100	1	50	28	—	—	16	10
SPZ 106-1	110	106	1	50	28	—	—	16	10
SPZ 112-1	116	112	1	50	28	—	—	16	10
SPZ 118-1	122	118	3	50	28	93	8	16	10
SPZ 125-1	129	125	3	50	28	100	8	16	15
SPZ 132-1	136	132	3	50	28	106	8	16	15
SPZ 140-1	144	140	3	50	28	114	8	16	15
SPZ 150-1	154	150	3	50	28	124	8	16	15
SPZ 160-1	164	160	3	55	32	134	8	16	15
SPZ 180-1	184	180	5	55	32	154	8	16	20
SPZ 200-1	204	200	5	55	32	174	8	16	20
SPZ 224-1	228	224	5	55	32	198	8	16	20
SPZ 250-1	254	250	5	55	32	224	8	16	20

Pilot Bore V-Pulleys according to BS3790 - 1981

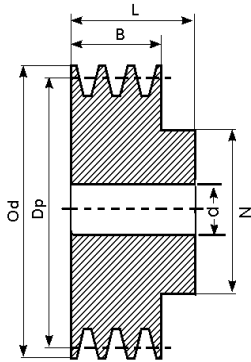

Form 1

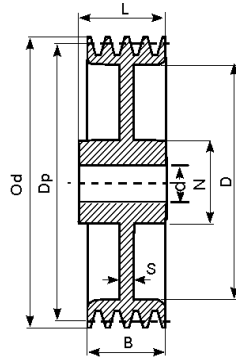

Form 3

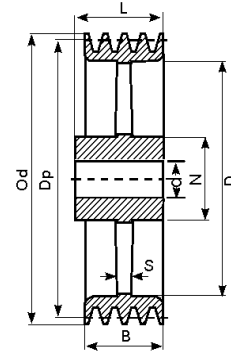

Form 5

SPZ - 2

Description	Od	Dp	Form	N	L	J	E	B	d
SPZ 50-2	54	50	1	40	35	—	—	28	10
SPZ 56-2	60	56	1	45	35	—	—	28	10
SPZ 63-2	67	63	1	50	35	—	—	28	10
SPZ 71-2	75	71	1	55	35	—	—	28	10
SPZ 75-2	79	75	1	60	35	—	—	28	10
SPZ 80-2	84	80	1	60	35	—	—	28	10
SPZ 85-2	89	85	1	60	35	—	—	28	10
SPZ 90-2	94	90	1	60	35	—	—	28	10
SPZ 95-2	99	95	1	60	35	—	—	28	15
SPZ 100-2	104	100	1	60	35	—	—	28	15
SPZ 106-2	110	106	1	60	35	—	—	28	15
SPZ 112-2	116	112	1	60	35	—	—	28	15
SPZ 118-2	122	118	3	60	35	97	8	28	15
SPZ 125-2	129	125	3	60	35	99	8	28	15
SPZ 132-2	136	132	3	60	40	105	8	28	15
SPZ 140-2	144	140	3	60	40	114	8	28	15
SPZ 150-2	154	150	3	60	40	124	8	28	15
SPZ 160-2	164	160	3	60	40	134	8	28	15
SPZ 180-2	184	180	5	60	40	154	8	28	20
SPZ 200-2	204	200	5	60	40	174	8	28	20
SPZ 224-2	228	224	5	60	40	198	8	28	20
SPZ 250-2	254	250	5	60	40	224	10	28	20
SPZ 280-2	284	280	5	65	45	254	10	28	20
SPZ 315-2	319	315	5	65	45	289	10	28	20

Pilot Bore V-Pulleys according to BS3790 - 1981

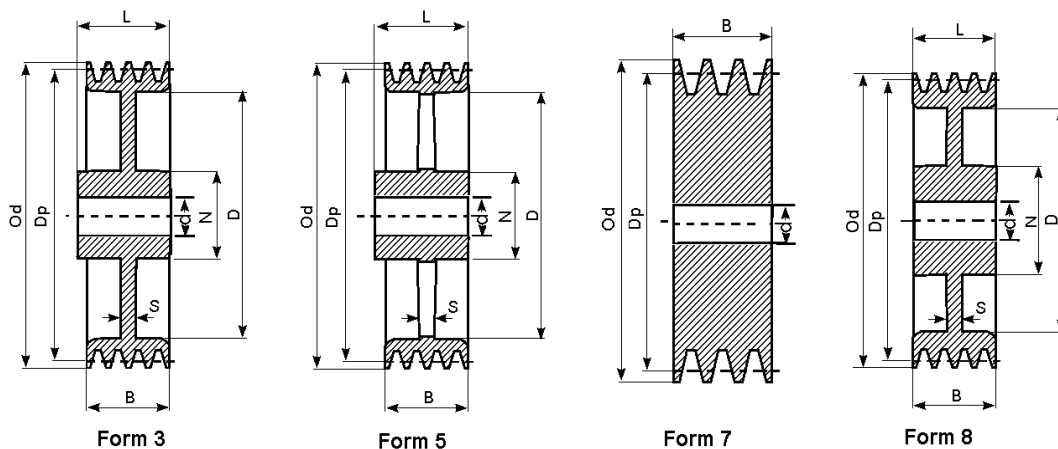

SPZ - 3

Description	Od	Dp	Form	N	L	J	E	B	d
SPZ 50-3	54	50	7	—	—	—	—	40	10
SPZ 56-3	60	56	7	—	—	—	—	40	10
SPZ 63-3	67	63	7	—	—	—	—	40	10
SPZ 71-3	75	71	7	—	—	—	—	40	10
SPZ 75-3	79	75	7	—	—	—	—	40	10
SPZ 80-3	84	80	7	—	—	—	—	40	10
SPZ 85-3	89	85	7	—	—	—	—	40	15
SPZ 90-3	94	90	7	—	—	—	—	40	15
SPZ 95-3	99	95	7	—	—	—	—	40	15
SPZ 100-3	104	100	7	—	—	—	—	40	15
SPZ 106-3	110	106	7	—	—	—	—	40	15
SPZ 112-3	116	112	7	—	—	—	—	40	15
SPZ 118-3	122	118	7	—	—	—	—	40	15
SPZ 125-3	129	125	7	—	—	—	—	40	15
SPZ 132-3	136	132	8	60	40	106	8	40	15
SPZ 140-3	140	140	8	60	40	114	8	40	15
SPZ 150-3	154	150	8	60	40	124	8	40	20
SPZ 160-3	164	160	3	65	45	134	8	40	20
SPZ 180-3	184	180	5	65	45	154	8	40	20
SPZ 200-3	204	200	5	65	45	174	10	40	20
SPZ 224-3	228	224	5	65	45	198	10	40	20
SPZ 250-3	254	250	5	65	45	224	12	40	20



Pilot Bore V-Pulleys according to BS3790 - 1981

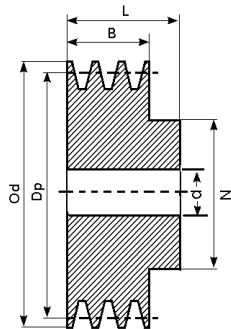

Form 1

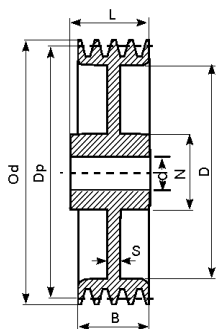

Form 3

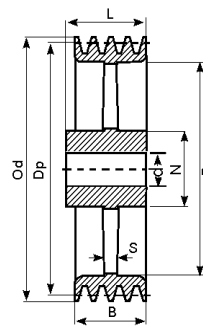

Form 5

SPA - 1									
Description	Od	Dp	Form	N	L	J	E	B	d
SPA 40-1	45,5	40	1	40	35	—	—	20	10
SPA 50-1	55,5	50	1	40	35	—	—	20	10
SPA 60-1	65,5	60	1	40	35	—	—	20	10
SPA 71-1	76,5	71	1	40	40	—	—	20	10
SPA 75-1	80,5	75	1	40	40	—	—	20	10
SPA 80-1	85,5	80	1	45	40	—	—	20	10
SPA 85-1	90,5	85	1	45	40	—	—	20	10
SPA 90-1	95,5	90	1	45	40	—	—	20	10
SPA 95-1	100,5	95	1	45	40	—	—	20	10
SPA 100-1	105,5	100	1	48	40	—	—	20	10
SPA 106-1	111,5	106	1	48	40	—	—	20	10
SPA 112-1	117,5	112	1	48	40	—	—	20	10
SPA 118-1	123,5	118	1	60	40	—	—	20	15
SPA 132-1	137,5	132	1	60	40	—	—	20	15
SPA 140-1	145,5	140	3	60	40	107	10	20	15
SPA 150-1	155,5	150	3	60	40	117	10	20	15
SPA 160-1	165,5	160	3	60	40	127	10	20	15
SPA 170-1	175,5	170	3	60	40	137	10	20	15
SPA 180-1	185,5	180	3	65	40	147	10	20	20
SPA 200-1	205,5	200	3	65	45	167	10	20	20
SPA 224-1	229,5	224	3	65	45	192	10	20	20
SPA 250-1	255,5	250	3	75	50	217	12	20	20
SPA 280-1	285,5	280	5	75	50	247	14	20	20
SPA 300-1	305,5	300	5	75	50	267	14	20	20
SPA 315-1	320,5	315	5	75	50	282	14	20	20
SPA 355-1	360,5	355	5	75	50	322	14	20	20
SPA 400-1	405,5	400	5	90	50	367	14	20	20
SPA 450-1	455,5	450	5	90	50	417	14	20	20

Pilot Bore V-Pulleys according to BS3790 - 1981

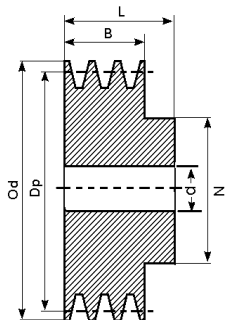

Form 1

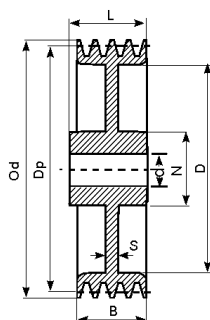

Form 3

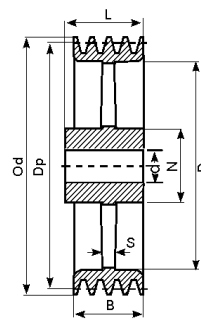

Form 5

SPA - 2									
Description	Od	Dp	Form	N	L	J	E	B	d
SPA 50-2	55,5	50	1	40	45	—	—	35	10
SPA 60-2	65,5	60	1	40	45	—	—	35	10
SPA 71-2	76,5	71	1	50	45	—	—	35	10
SPA 75-2	80,5	75	1	50	45	—	—	35	10
SPA 80-2	85,5	80	1	50	45	—	—	35	10
SPA 85-2	90,5	85	1	50	45	—	—	35	10
SPA 90-2	95,5	90	1	60	45	—	—	35	15
SPA 95-2	100,5	95	1	60	45	—	—	35	15
SPA 100-2	105,5	100	1	60	45	—	—	35	15
SPA 106-2	111,5	106	1	60	45	—	—	35	15
SPA 112-2	116,5	112	1	60	45	—	—	35	15
SPA 118-2	123,5	118	1	60	45	—	—	35	15
SPA 132-2	137,5	132	1	60	45	—	—	35	15
SPA 140-2	145,5	140	3	60	45	107	10	35	15
SPA 150-2	155,5	150	3	60	45	117	10	35	15
SPA 160-2	165,5	160	3	60	45	127	10	35	15
SPA 170-2	175,5	170	3	60	45	137	12	35	15
SPA 180-2	185,5	180	3	70	50	147	12	35	20
SPA 200-2	205,5	200	3	70	50	167	12	35	20
SPA 224-2	229,5	224	3	70	50	192	12	35	20
SPA 250-2	255,5	250	3	75	50	217	12	35	20
SPA 280-2	285,5	280	5	80	50	247	14	35	20
SPA 300-2	305,5	300	5	80	50	267	14	35	20
SPA 315-2	320,5	315	5	80	50	282	14	35	20
SPA 355-2	360,5	355	5	80	50	322	14	35	20
SPA 400-2	405,5	400	5	90	50	367	14	35	20
SPA 450-2	455,5	450	5	100	50	417	14	35	25
SPA 500-2	505,5	500	5	100	50	467	16	35	25
SPA 560-2	565,5	560	5	100	50	527	18	35	25
SPA 600-2	605,5	600	5	110	50	567	18	35	25
SPA 630-2	635,5	630	5	110	50	597	18	35	25

Pilot Bore V-Pulleys according to BS3790 - 1981

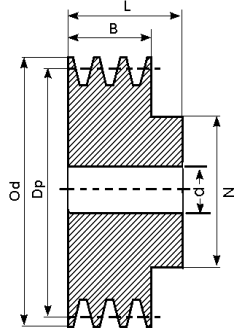

Form 1

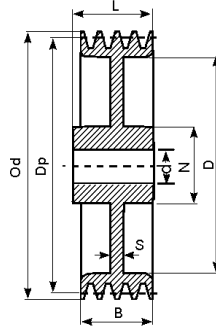

Form 3

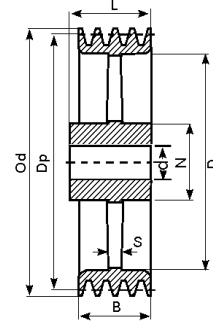

Form 5

SPA - 3									
Description	Od	Dp	Form	N	L	J	E	B	d
SPA 60-3	65,5	60	2	—	—	—	—	50	10
SPA 71-3	76,5	71	1	52	52	—	—	50	10
SPA 75-3	80,5	75	2	—	—	—	—	50	10
SPA 80-3	85,5	80	2	—	—	—	—	50	15
SPA 85-3	90,5	85	2	—	—	—	—	50	15
SPA 90-3	95,5	90	2	—	—	—	—	50	15
SPA 95-3	100,5	95	2	—	—	—	—	50	15
SPA 100-3	105,5	100	2	—	—	—	—	50	15
SPA 112-3	117,5	112	2	—	—	—	—	50	15
SPA 118-3	133,5	118	2	—	—	—	—	50	15
SPA 132-3	137,5	132	2	—	—	—	—	50	15
SPA 140-3	145,5	140	3	65	52	107	12	50	15
SPA 150-3	155,5	150	3	65	52	117	12	50	20
SPA 160-3	165,5	160	3	70	52	127	12	50	20
SPA 170-3	175,5	170	3	70	52	137	12	50	20
SPA 180-3	185,5	180	3	70	52	147	12	50	20
SPA 200-3	205,5	200	3	70	52	167	12	50	20
SPA 224-3	229,5	224	3	80	52	192	12	50	20
SPA 250-3	255,5	250	3	80	60	217	12	50	20
SPA 280-3	285,5	280	5	80	60	247	14	50	20
SPA 300-3	305,5	300	5	80	60	267	14	50	20
SPA 315-3	320,5	315	5	90	60	282	14	50	20
SPA 355-3	360,5	355	5	90	60	322	14	50	20
SPA 400-3	405,5	400	5	100	60	367	16	50	25
SPA 450-3	455,5	450	5	100	60	417	16	50	25
SPA 500-3	505,5	500	5	105	60	467	20	50	25
SPA 560-3	565,5	560	5	120	65	527	20	50	25
SPA 600-3	605,5	600	5	120	65	567	20	50	25
SPA 630-3	635,5	630	5	120	65	597	20	50	25

Pilot Bore V-Pulleys according to BS3790 - 1981

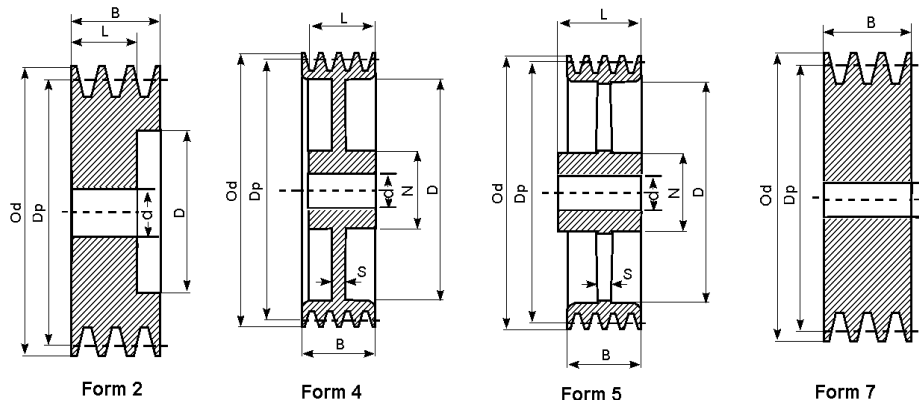

SPA - 4									
Description	Od	Dp	Form	N	L	J	E	B	d
SPA 75-4	80,5	75	7	—	—	—	—	65	10
SPA 80-4	85,5	80	7	—	—	—	—	65	15
SPA 85-4	90,5	85	7	—	—	—	—	65	15
SPA 90-4	95,5	90	7	—	—	—	—	65	15
SPA 95-4	100,5	95	7	—	—	—	—	65	15
SPA 100-4	105,5	100	2	—	52	67	—	65	15
SPA 112-4	117,5	112	2	—	52	79	—	65	15
SPA 118-4	123,5	118	2	—	52	87	—	65	15
SPA 132-4	137,5	132	2	—	52	97	—	65	15
SPA 140-4	145,5	140	2	—	52	107	—	65	20
SPA 150-4	155,5	150	2	—	52	117	—	65	20
SPA 160-4	165,5	160	4	70	52	127	12	65	20
SPA 170-4	175,5	170	4	80	52	137	12	65	20
SPA 180-4	185,5	180	4	80	60	147	12	65	20
SPA 200-4	205,5	200	4	80	60	167	12	65	20
SPA 224-4	229,5	224	4	90	60	192	12	65	20
SPA 250-4	255,5	250	3	90	65	217	12	65	20
SPA 280-4	285,5	280	5	90	65	247	14	65	20
SPA 300-4	305,5	300	5	90	65	267	14	65	20
SPA 315-4	320,5	315	5	90	65	282	14	65	20
SPA 355-4	360,5	355	5	90	65	322	16	65	25
SPA 400-4	405,5	400	5	100	65	367	20	65	25
SPA 450-4	455,5	450	5	105	65	417	20	65	25
SPA 500-4	505,5	500	5	105	65	467	20	65	25
SPA 560-4	565,5	560	5	120	65	527	22	65	25
SPA 600-4	605,5	600	5	120	65	567	22	65	25
SPA 630-4	635,5	630	5	120	65	597	22	65	25



Pilot Bore V-Pulleys according to BS3790 - 1981

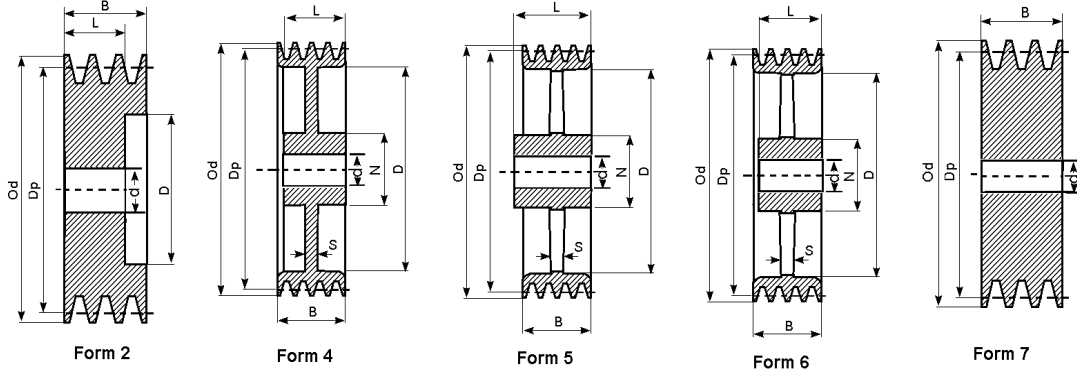

SPA - 5									
Description	Od	Dp	Form	N	L	J	E	B	d
SPA 75-5	80,5	75	7	—	—	—	—	80	10
SPA 80-5	85,5	80	7	—	—	—	—	80	15
SPA 85-5	90,5	85	7	—	—	—	—	80	15
SPA 90-5	95,5	90	7	—	—	—	—	80	15
SPA 95-5	100,5	95	7	—	—	—	—	80	15
SPA 100-5	105,5	100	2	—	52	67	—	80	15
SPA 112-5	117,5	112	2	—	52	79	—	80	15
SPA 118-5	123,5	118	2	—	52	87	—	80	15
SPA 132-5	137,5	132	2	—	52	97	—	80	15
SPA 140-5	145,5	140	2	—	52	107	—	80	20
SPA 150-5	155,5	150	2	—	52	117	—	80	20
SPA 160-5	165,5	160	4	80	52	127	12	80	20
SPA 170-5	175,5	170	4	80	52	137	12	80	20
SPA 180-5	185,5	180	4	80	65	147	12	80	20
SPA 200-5	205,5	200	4	80	65	167	12	80	20
SPA 224-5	229,5	224	4	90	65	192	12	80	20
SPA 250-5	255,5	250	4	90	65	217	12	80	20
SPA 280-5	285,5	280	6	100	65	247	14	80	25
SPA 300-5	305,5	300	6	100	65	267	14	80	25
SPA 315-5	320,5	315	6	100	65	282	16	80	25
SPA 355-5	360,5	355	6	100	65	322	18	80	25
SPA 400-5	405,5	400	6	100	65	367	22	80	25
SPA 450-5	455,5	450	6	105	65	417	22	80	25
SPA 500-5	505,5	500	6	110	65	467	22	80	25
SPA 560-5	565,5	560	5	120	80	527	24	80	25
SPA 600-5	605,5	600	5	120	80	567	24	80	25
SPA 630-5	635,5	630	5	120	80	597	24	80	25

Pilot Bore V-Pulleys according to BS3790 - 1981

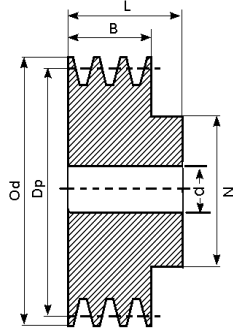

Form 1

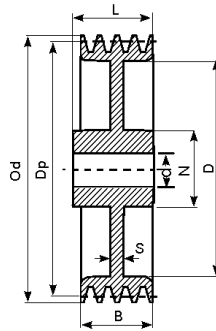

Form 3

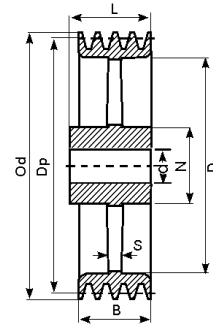

Form 5

SPB - 1									
Description	Od	Dp	Form	N	L	J	E	B	d
SPB 70-1	77	70	1	45	45	—	—	25	10
SPB 80-1	87	80	1	50	45	—	—	25	10
SPB 95-1	97	90	1	50	45	—	—	25	10
SPB 100-1	107	100	1	52	45	—	—	25	10
SPB 112-1	119	112	1	55	45	—	—	25	15
SPB 120-1	127	120	1	55	45	—	—	25	15
SPB 125-1	132	125	1	58	45	—	—	25	15
SPB 132-1	139	132	1	60	45	—	—	25	15
SPB 140-1	147	140	1	65	45	—	—	25	20
SPB 150-1	157	150	1	65	45	—	—	25	20
SPB 160-1	167	160	3	65	45	118	12	25	20
SPB 170-1	177	170	3	65	45	128	12	25	20
SPB 180-1	187	180	3	65	45	138	12	25	20
SPB 200-1	207	200	3	70	45	158	14	25	20
SPB 212-1	219	212	3	70	45	170	14	25	20
SPB 225-1	232	225	3	70	45	183	14	25	20
SPB 250-1	257	250	3	70	50	208	14	25	20
SPB 280-1	287	280	3	76	50	238	14	25	20
SPB 300-1	307	300	5	76	50	258	15	25	20
SPB 315-1	322	315	5	76	50	273	15	25	20
SPB 355-1	362	355	5	80	50	313	15	25	20
SPB 400-1	407	400	5	85	55	358	18	25	20
SPB 450-1	457	450	5	90	60	408	18	25	20
SPB 500-1	507	500	5	100	60	458	18	25	25
SPB 560-1	567	560	5	100	60	518	18	25	25
SPB 600-1	607	600	5	100	60	558	18	25	25
SPB 630-1	637	630	5	100	60	588	18	25	25

Pilot Bore V-Pulleys according to BS3790 - 1981

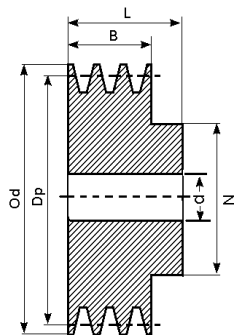

Form 1

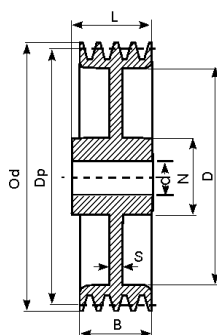

Form 3

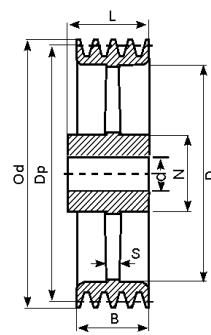

Form 5

SPB - 2

Description	Od	Dp	Form	N	L	J	E	B	d
SPB 70-2	77	70	1	45	55	—	—	44	10
SPB 80-2	87	80	1	50	55	—	—	44	10
SPB 95-2	97	90	1	50	55	—	—	44	10
SPB 100-2	107	100	1	55	55	—	—	44	15
SPB 112-2	119	112	1	60	55	—	—	44	15
SPB 120-2	127	120	1	60	55	—	—	44	15
SPB 125-2	132	125	1	60	55	—	—	44	15
SPB 132-2	139	132	1	60	55	—	—	44	15
SPB 140-2	147	140	1	65	55	—	—	44	20
SPB 150-2	157	150	1	65	55	—	—	44	20
SPB 160-2	167	160	3	70	55	118	12	44	20
SPB 170-2	177	170	3	70	55	128	12	44	20
SPB 180-2	187	180	3	70	55	138	12	44	20
SPB 200-2	207	200	3	70	55	158	12	44	20
SPB 212-2	219	212	3	77	55	170	14	44	20
SPB 225-2	232	225	3	77	55	183	14	44	20
SPB 250-2	257	250	3	77	55	208	14	44	20
SPB 280-2	287	280	3	80	55	238	14	44	20
SPB 300-2	307	300	5	80	55	258	15	44	20
SPB 315-2	322	315	5	88	60	273	15	44	20
SPB 355-2	362	355	5	88	60	313	15	44	20
SPB 400-2	407	400	5	88	60	358	18	44	20
SPB 450-2	457	450	5	90	60	408	18	44	20
SPB 500-2	507	500	5	100	65	458	20	44	25
SPB 560-2	567	560	5	100	65	518	20	44	25
SPB 600-2	607	600	5	100	65	558	20	44	25
SPB 630-2	637	630	5	100	65	588	20	44	25



Pilot Bore V-Pulleys according to BS3790 - 1981

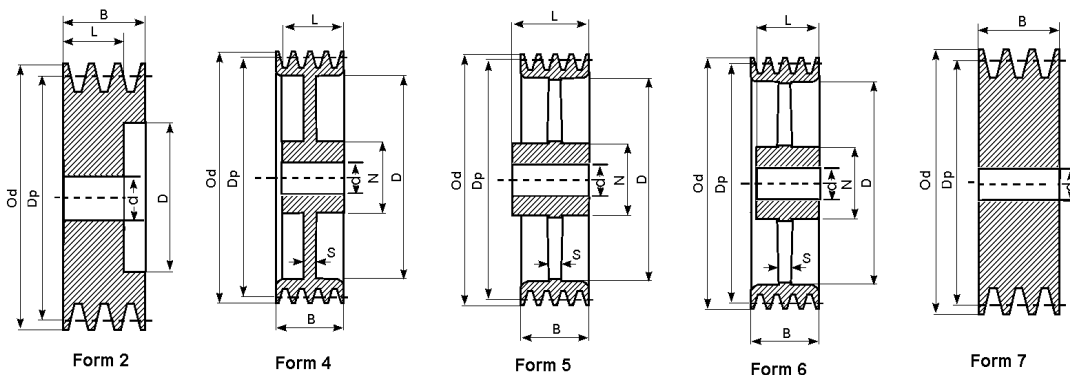

SPB - 3									
Description	Od	Dp	Form	N	L	J	E	B	d
SPB 80-3	87	80	7	—	—	—	—	63	15
SPB 90-3	97	90	7	—	—	—	—	63	15
SPB 100-3	107	100	7	—	—	—	—	63	15
SPB 112-3	119	112	7	—	—	—	—	63	15
SPB 120-3	127	120	7	—	—	—	—	63	15
SPB 125-3	132	125	2	—	60	83	—	63	15
SPB 132-3	139	132	2	—	60	88	—	63	15
SPB 140-3	147	140	2	—	60	98	—	63	20
SPB 150-3	157	150	2	—	60	108	—	63	20
SPB 160-3	167	160	2	—	60	118	—	63	20
SPB 170-3	177	170	4	70	60	128	18	63	20
SPB 180-3	187	180	4	80	60	138	18	63	20
SPB 200-3	207	200	4	80	60	158	18	63	20
SPB 212-3	219	212	4	80	60	170	18	63	20
SPB 225-3	232	225	4	80	60	183	18	63	20
SPB 250-3	257	250	4	80	60	208	18	63	20
SPB 280-3	287	280	4	90	60	238	18	63	20
SPB 300-3	307	300	6	90	60	258	18	63	20
SPB 315-3	322	315	6	90	60	273	18	63	20
SPB 355-3	362	355	6	92	60	313	18	63	25
SPB 400-3	407	400	5	96	65	358	22	63	25
SPB 450-3	457	450	5	96	65	408	22	63	25
SPB 500-3	507	500	5	104	75	458	24	63	25
SPB 560-3	567	560	5	104	75	518	24	63	25
SPB 600-3	607	600	5	104	75	558	24	63	25
SPB 630-3	637	630	5	105	75	588	26	63	25

Pilot Bore V-Pulleys according to BS3790 - 1981

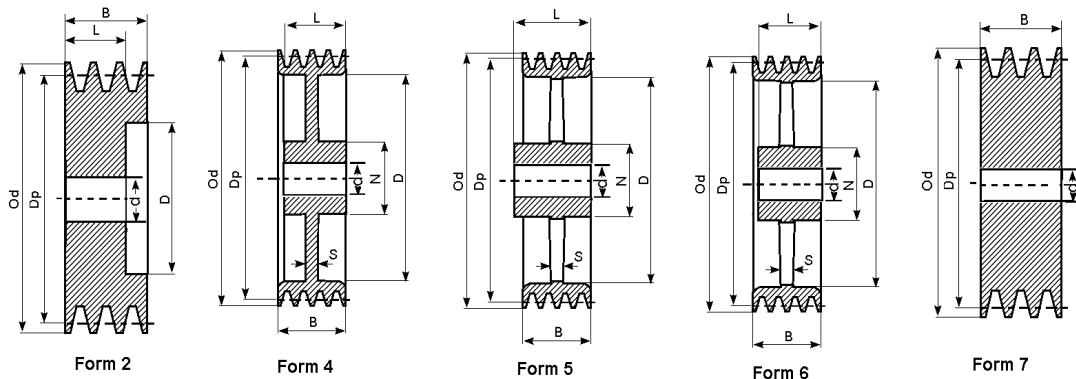

SPB - 4

Description	Od	Dp	Form	N	L	J	E	B	d
SPB 80-4	87	80	7	—	—	—	—	82	15
SPB 90-4	97	90	7	—	—	—	—	82	15
SPB 100-4	107	100	7	—	—	—	—	82	15
SPB 112-4	119	112	7	—	—	—	—	82	20
SPB 120-4	127	120	7	—	—	—	—	82	20
SPB 125-4	132	125	2	—	60	83	—	82	20
SPB 132-4	139	132	2	—	60	88	—	82	20
SPB 140-4	147	140	2	—	60	98	—	82	20
SPB 150-4	157	150	2	—	60	108	—	82	20
SPB 160-4	167	160	2	—	60	118	—	82	20
SPB 170-4	177	170	4	70	60	128	20	82	20
SPB 180-4	187	180	4	80	60	138	20	82	20
SPB 200-4	207	200	4	88	60	158	25	82	20
SPB 212-4	219	212	4	88	60	170	25	82	20
SPB 225-4	232	225	4	88	60	183	25	82	20
SPB 250-4	257	250	4	96	65	208	25	82	25
SPB 280-4	287	280	4	96	65	238	25	82	25
SPB 300-4	307	300	6	96	65	258	20	82	25
SPB 315-4	322	315	6	96	65	273	20	82	25
SPB 355-4	362	355	6	96	65	313	20	82	25
SPB 400-4	407	400	6	104	75	358	24	82	25
SPB 450-4	457	450	6	104	75	408	24	82	25
SPB 500-4	507	500	5	112	85	458	28	82	25
SPB 560-4	567	560	5	112	85	518	28	82	25
SPB 600-4	607	600	5	115	85	558	28	82	25
SPB 630-4	637	630	5	120	85	588	28	82	25

Pilot Bore V-Pulleys according to BS3790 - 1981

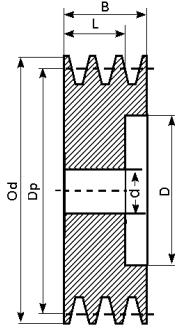

Form 2

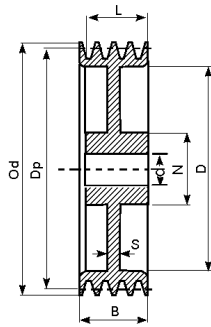

Form 4

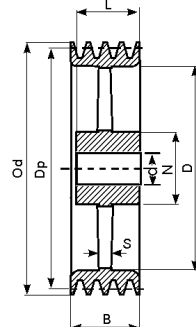

Form 6

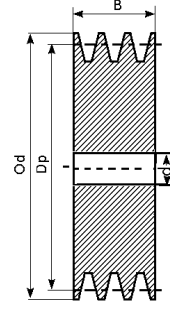

Form 7

SPB - 5									
Description	Od	Dp	Form	N	L	J	E	B	d
SPB 80-5	87	80	7	—	—	—	—	101	15
SPB 90-5	97	90	7	—	—	—	—	101	15
SPB 100-5	107	100	7	—	—	—	—	101	15
SPB 112-5	119	112	7	—	—	—	—	101	15
SPB 120-5	127	120	7	—	—	—	—	101	20
SPB 125-5	132	125	2	—	60	83	—	101	20
SPB 132-5	139	132	2	—	60	88	—	101	20
SPB 140-5	147	140	2	—	60	98	—	101	20
SPB 150-5	157	150	2	—	60	108	—	101	20
SPB 160-5	167	160	2	—	60	118	—	101	20
SPB 170-5	177	170	4	70	60	128	22	101	20
SPB 180-5	187	180	4	80	70	138	22	101	20
SPB 200-5	207	200	4	96	70	158	25	101	25
SPB 212-5	219	212	4	96	70	170	25	101	25
SPB 225-5	232	225	4	96	70	183	25	101	25
SPB 250-5	257	250	4	104	75	208	25	101	25
SPB 280-5	287	280	4	104	75	238	25	101	25
SPB 300-5	307	300	6	104	75	258	22	101	25
SPB 315-5	322	315	6	104	75	273	22	101	25
SPB 355-5	362	355	6	104	75	313	22	101	25
SPB 400-5	407	400	6	112	85	358	24	101	25
SPB 450-5	457	450	6	112	85	408	26	101	25
SPB 500-5	507	500	6	120	90	458	30	101	25
SPB 560-5	567	560	6	120	90	518	30	101	25
SPB 600-5	607	600	6	120	90	558	30	101	25
SPB 630-5	637	630	6	128	90	588	30	101	25

Pilot Bore V-Pulleys according to BS3790 - 1981

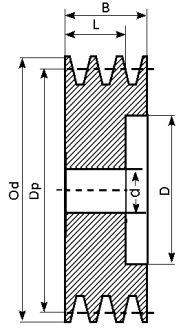

Form 2

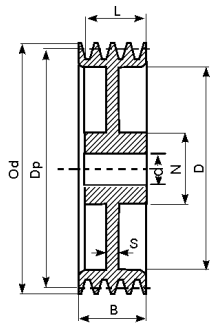

Form 4

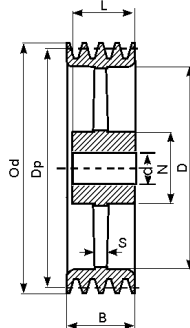

Form 6

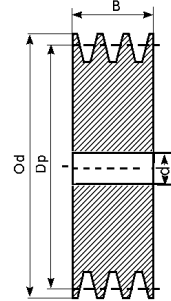

Form 7

SPB - 6									
Description	Od	Dp	Form	N	L	J	E	B	d
SPB 120-6	127	120	7	—	—	—	—	120	20
SPB 125-6	132	125	2	—	60	83	—	120	20
SPB 132-6	139	132	2	—	60	88	—	120	20
SPB 140-6	147	140	2	—	60	98	—	120	20
SPB 150-6	157	150	2	—	60	108	—	120	20
SPB 160-6	167	160	2	—	65	118	—	120	20
SPB 170-6	177	170	4	70	65	128	22	120	20
SPB 180-6	187	180	4	80	70	138	22	120	20
SPB 200-6	207	200	4	96	70	158	25	120	25
SPB 212-6	219	212	4	104	80	170	25	120	25
SPB 225-6	232	225	4	104	80	183	25	120	25
SPB 250-6	257	250	4	104	80	208	25	120	25
SPB 280-6	287	280	4	104	80	238	25	120	25
SPB 300-6	307	300	6	104	80	258	25	120	25
SPB 315-6	322	315	6	120	90	273	25	120	25
SPB 355-6	362	355	6	120	90	313	25	120	25
SPB 400-6	407	400	6	120	100	358	28	120	25
SPB 450-6	457	450	6	120	100	408	28	120	25
SPB 500-6	507	500	6	129	105	458	33	120	25
SPB 560-6	567	560	6	129	105	518	33	120	25
SPB 600-6	607	600	6	129	105	558	33	120	25
SPB 630-6	637	630	6	140	105	588	33	120	25

Pilot Bore V-Pulleys according to BS3790 - 1981

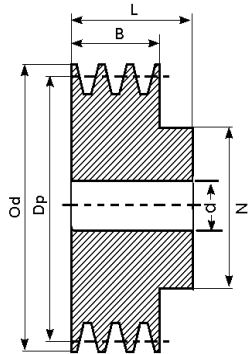

Form 1

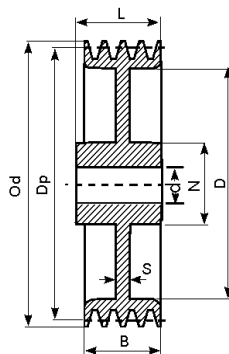

Form 3

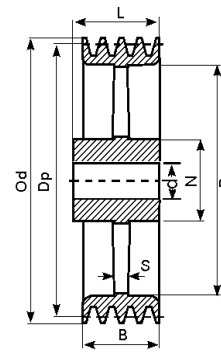

Form 5

SPC - 1

Description	Od	Dp	Form	N	L	J	E	B	d
SPC 100-1	109,6	100	1	60	50	—	—	34	15
SPC 120-1	129,6	120	1	65	50	—	—	34	15
SPC 140-1	149,6	140	1	70	50	—	—	34	20
SPC 150-1	159,6	150	1	70	50	—	—	34	20
SPC 160-1	169,6	160	1	72	50	—	—	34	20
SPC 180-1	189,6	180	3	76	50	123	16	34	20
SPC 200-1	209,6	200	3	76	50	143	16	34	20
SPC 225-1	234,6	225	3	86	50	168	16	34	20
SPC 250-1	259,6	250	3	86	50	193	16	34	20
SPC 280-1	289,6	280	3	86	50	223	16	34	20
SPC 300-1	309,6	300	3	86	50	243	16	34	20
SPC 315-1	324,6	315	5	92	50	258	16	34	20
SPC 340-1	349,6	340	5	100	50	283	16	34	20
SPC 355-1	364,5	355	5	110	50	298	16	34	20
SPC 400-1	409,6	400	5	110	60	343	18	34	25
SPC 450-1	459,6	450	5	110	60	393	18	34	25
SPC 500-1	509,6	500	5	114	60	443	18	34	25
SPC 560-1	569,6	560	5	114	60	503	20	34	25
SPC 600-1	609,6	600	5	114	60	543	20	34	25
	639,6	630	5	114	60	573	20	34	25

Pilot Bore V-Pulleys according to BS3790 - 1981

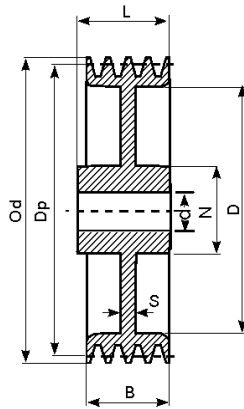

Form 3

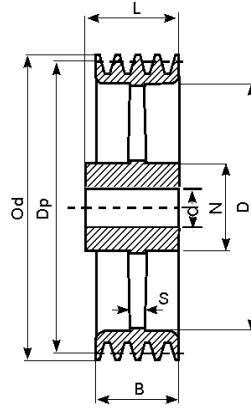

Form 5

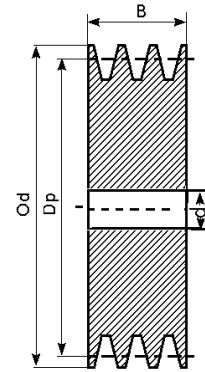

Form 7

SPC - 2

Description	Od	Dp	Form	N	L	J	E	B	d
SPC 120-2	129,6	120	7	—	—	—	—	59,5	15
SPC 140-2	149,6	140	7	—	—	—	—	59,5	20
SPC 150-2	159,6	150	7	—	—	—	—	59,5	20
SPC 160-2	169,6	160	7	—	—	—	—	59,5	20
SPC 180-2	180,6	180	3	80	60	123	16	59,5	20
SPC 200-2	209,6	200	3	80	60	143	16	59,5	20
SPC 225-2	234,6	225	3	88	60	168	18	59,5	20
SPC 250-2	259,6	250	3	92	60	193	18	59,5	20
SPC 280-2	289,6	280	3	92	60	223	18	59,5	20
SPC 300-2	309,6	300	3	92	60	243	18	59,5	20
SPC 315-2	324,6	315	5	92	60	258	18	59,5	20
SPC 340-2	349,6	340	5	100	60	283	18	59,5	20
SPC 355-2	364,6	355	5	110	60	298	18	59,5	25
SPC 400-2	409,6	400	5	110	70	343	20	59,5	25
SPC 450-2	459,6	450	5	110	70	393	20	59,5	25
SPC 500-2	509,6	500	5	114	70	443	20	59,5	25
SPC 560-2	569,6	560	5	114	70	503	24	59,5	25
SPC 600-2	609,6	600	5	114	70	543	24	59,5	25
SPC 630-2	639,6	630	5	114	70	573	24	59,5	25

Pilot Bore V-Pulleys according to BS3790 - 1981

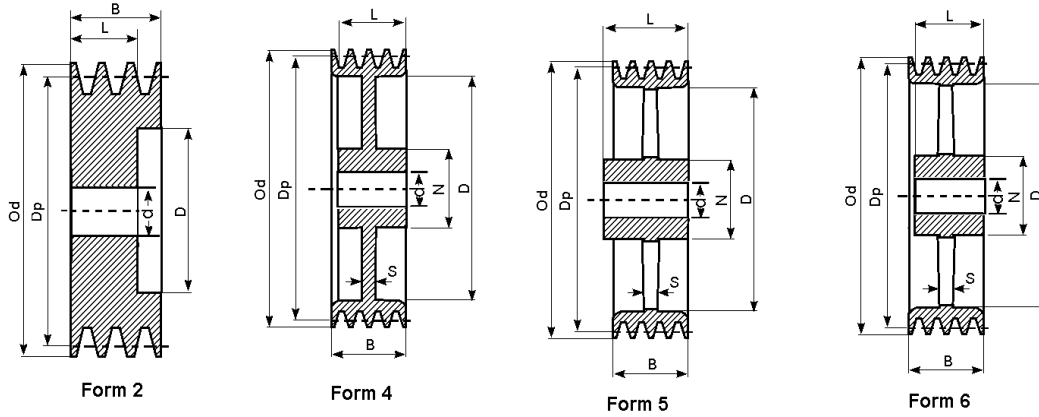

SPC - 3

Description	Od	Dp	Form	N	L	J	E	B	d
SPC 140-3	149,6	140	2	—	65	83	—	85	20
SPC 150-3	159,6	150	2	—	65	93	—	85	20
SPC 160-3	169,6	160	2	—	65	103	—	85	20
SPC 180-3	189,6	180	4	82	65	123	18	85	20
SPC 200-3	209,6	200	4	86	65	143	18	85	20
SPC 225-3	234,6	225	4	90	70	168	21	85	20
SPC 250-3	259,6	250	4	92	70	193	21	85	20
SPC 280-3	289,6	280	4	92	70	223	21	85	20
SPC 300-3	309,6	300	4	92	70	243	21	85	20
SPC 315-3	324,6	315	6	92	70	258	22	85	25
SPC 340-3	349,6	340	6	100	70	283	22	85	25
SPC 355-3	364,6	355	6	110	70	298	22	85	25
SPC 400-3	409,6	400	5	114	90	343	24	85	25
SPC 450-3	459,6	450	5	114	90	393	24	85	25
SPC 500-3	509,6	500	5	114	90	443	24	85	25
SPC 560-3	569,6	560	5	114	90	503	28	85	25
SPC 600-3	609,6	600	5	114	90	543	28	85	25
SPC 630-3	639,6	630	5	114	90	573	28	85	25

Pilot Bore V-Pulleys according to BS3790 - 1981

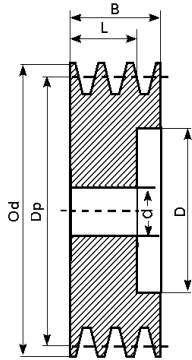

Form 2

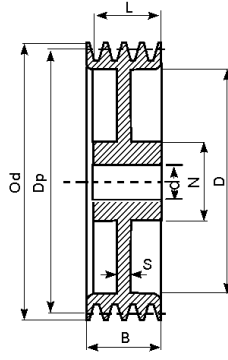

Form 4

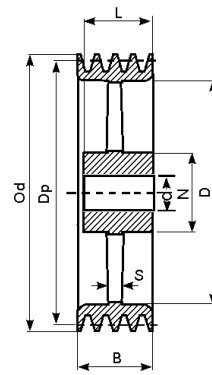

Form 6

SPC - 4

Description	Od	Dp	Form	N	L	J	E	B	d
SPC 140-4	149,6	140	2	—	80	83	—	110,5	20
SPC 150-4	159,6	150	2	—	80	93	—	110,5	20
SPC 160-4	169,6	160	2	—	80	103	—	110,5	20
SPC 180-4	189,6	180	4	82	80	123	20	110,5	20
SPC 200-4	209,6	200	4	90	90	143	25	110,5	20
SPC 225-4	234,6	225	4	90	90	168	25	110,5	25
SPC 250-4	259,6	250	4	100	90	193	25	110,5	25
SPC 280-4	289,6	280	4	100	90	223	25	110,5	25
SPC 300-4	309,6	300	4	100	90	243	25	110,5	25
SPC 315-4	324,6	315	6	110	90	258	25	110,5	25
SPC 340-4	349,6	340	6	114	90	283	25	110,5	25
SPC 355-4	364,6	355	6	114	90	298	25	110,5	25
SPC 400-4	409,6	400	6	114	90	343	26	110,5	25
SPC 450-4	459,6	450	6	120	90	393	28	110,5	25
SPC 500-4	509,6	500	6	126	90	443	28	110,5	25
SPC 560-4	569,6	560	6	130	90	503	30	110,5	25
SPC 600-4	609,6	600	6	130	90	543	30	110,5	25
SPC 630-4	639,6	630	6	130	90	573	30	110,5	25

Pilot Bore V-Pulleys according to BS3790 - 1981

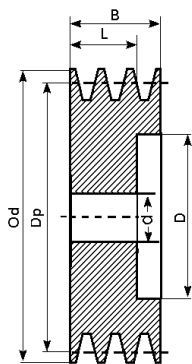

Form 2

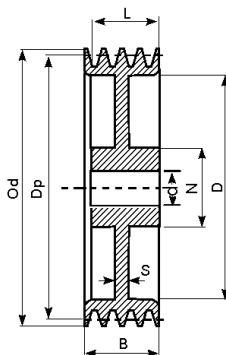

Form 4

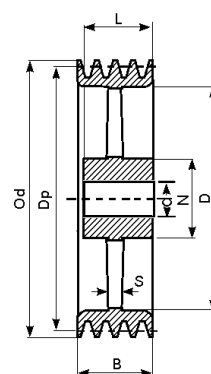

Form 6

SPC - 5

Description	Od	Dp	Form	N	L	J	E	B	d
SPC 150-5	159,6	150	2	—	96	93	—	136	20
SPC 160-5	169,6	160	2	—	96	103	—	136	20
SPC 180-5	189,6	180	4	82	96	123	20	136	20
SPC 200-5	209,6	200	4	90	100	143	25	136	25
SPC 225-5	234,6	225	4	90	100	168	25	136	25
SPC 250-5	259,6	250	4	102	100	193	25	136	25
SPC 280-5	289,6	280	4	102	100	223	25	136	25
SPC 300-5	309,6	300	4	104	100	243	25	136	25
SPC 315-5	324,6	315	4	112	100	258	25	136	25
SPC 340-5	349,6	340	6	114	100	283	28	136	25
SPC 355-5	364,6	355	6	114	100	298	28	136	25
SPC 400-5	409,6	400	6	120	100	343	28	136	25
SPC 450-5	459,6	450	6	120	100	393	30	136	25
SPC 500-5	509,6	500	6	126	100	443	30	136	25
SPC 560-5	569,6	560	6	130	100	503	32	136	25
SPC 600-5	609,6	600	6	130	100	543	32	136	25
SPC 630-5	639,6	630	6	130	100	573	32	136	25

Pilot Bore V-Pulleys according to BS3790 - 1981

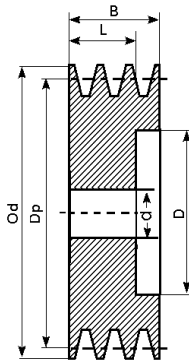

Form 2

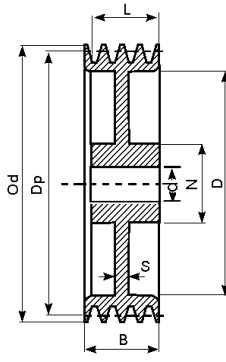

Form 4

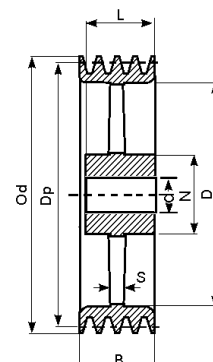

Form 6

SPC - 6

Description	Od	Dp	Form	N	L	J	E	B	d
SPC 160-6	169,6	160	2	—	96	103	—	161,5	20
SPC 180-6	189,6	180	4	82	96	123	25	161,5	20
SPC 200-6	209,6	200	4	90	100	143	25	161,5	25
SPC 225-6	234,6	225	4	90	100	168	25	161,5	25
SPC 250-6	259,6	250	4	102	100	193	25	161,5	25
SPC 280-6	289,6	280	4	102	100	223	25	161,5	25
SPC 300-6	309,6	300	4	104	100	243	25	161,5	25
SPC 315-6	324,6	315	4	112	100	258	28	161,5	25
SPC 340-6	349,6	340	6	114	100	283	30	161,5	25
SPC 355-6	364,6	355	6	114	100	298	30	161,5	25
SPC 400-6	409,6	400	6	120	100	343	30	161,5	25
SPC 450-6	459,6	450	6	120	100	393	32	161,5	25
SPC 500-6	509,6	500	6	126	100	443	32	161,5	25
SPC 560-6	569,6	560	6	130	100	503	35	161,5	25
SPC 600-6	609,6	600	6	130	100	543	35	161,5	25
SPC 630-6	639,6	630	6	130	100	573	35	161,5	25